

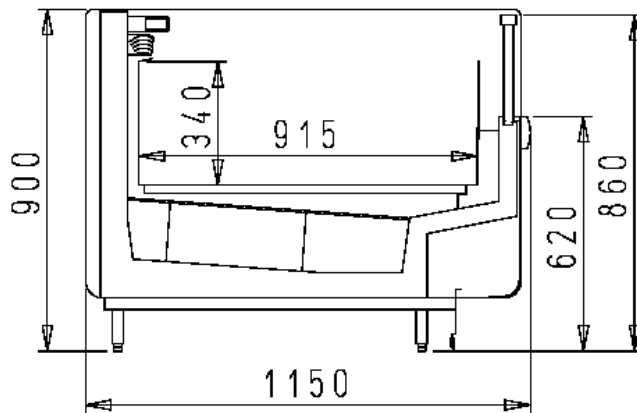

Commercial and Industrial Refrigeration

## Antares 115 SCH

-18°C / -25°C  
+ 25° C 60% UR



**The total amount includes:**

Decoration trims, blue RAL 5019  
Thermopane front glass  
Electric defrosting  
Fan assisted refrigeration  
R404A valve  
2 ends with thermopan glass, thickness 83mm each

- a) - TERMINAL BOARD  
with mechanical thermometer
- b) - ELECTRONIC CONTROL BOARD  
with digital control















**AKVATEK**

15701 NW 15<sup>th</sup> Ave. Miami, FL 33169 Tel.866-283-8766 Fax. 888-230-9388 [www.abc-supermarket.com](http://www.abc-supermarket.com)

## DEALER NET PRICE

| Length                |                 | code       | TOTAL (a)<br>TERMINAL BOARD<br>with ends 83mm<br>without ends |                    | TOTAL (b)<br>ELECTRONIC<br>with ends 83 mm without<br>ends |                    |
|-----------------------|-----------------|------------|---|--------------------|--|--------------------|
| with<br>ends<br>83 mm | without<br>ends |            |   |                    |  |                    |
| <b>2666</b>           | 2500            | 9.58.02.60 | <b>\$8,796.21</b>   | <b>\$7,088.34</b>  | <b>\$9,051.56</b>  | <b>\$7,343.69</b>  |
| <b>3916</b>           | 3750            | 9.58.02.70 | <b>\$10,956.12</b>  | <b>\$9,248.25</b>  | <b>\$11,211.47</b>   | <b>\$9,503.60</b>  |
| <b>5166</b>           | 2500+2500       |            | <b>\$15,820.16</b>  | <b>\$14,112.29</b> | <b>\$16,510.61</b>   | <b>\$14,802.74</b> |
| <b>6416</b>           | 2500+3750       |            | <b>\$18,159.83</b>  | <b>\$16,451.96</b> | <b>\$18,670.52</b>   | <b>\$16,962.65</b> |
| <b>7666</b>           | 3750+3750       |            | <b>\$20,319.74</b>  | <b>\$18,611.87</b> | <b>\$20,830.43</b>   | <b>\$19,122.56</b> |
| <b>8916</b>           | 2500+2500+3750  |            | <b>\$25,363.53</b>  | <b>\$23,655.66</b> | <b>\$26,129.57</b>   | <b>\$24,421.70</b> |
| <b>10166</b>          | 2500+3750+3750  |            | <b>\$27,523.44</b>  | <b>\$25,815.57</b> | <b>\$28,289.48</b>   | <b>\$26,581.61</b> |
| <b>11416</b>          | 3750+3750+3750  |            | <b>\$29,683.35</b>  | <b>\$27,975.48</b> | <b>\$30,449.39</b>   | <b>\$28,741.52</b> |

## OPTIONAL COLORS

|                     |          |   |                 |          |   |
|---------------------|----------|---|-----------------|----------|---|
| Yellow              | RAL 1007 |  | Gentian Blue    | RAL 5010 |  |
| Yellow              | RAL 1016 |  | Yellow Green    | RAL 6018 |  |
| Yellow              | RAL 1021 |  | Light Grey      | RAL 7035 |  |
| Pure Orange         | RAL 2004 |  | Chocolate Brown | RAL 8017 |  |
| Light Ivory         | RAL 1015 |  | Grey White      | RAL 9002 |  |
| ORANGE              | RAL 202  |  | White Aluminum  | RAL 9006 |  |
| Ultramarine<br>Blue | RAL 5002 |  | May Green       | RAL 6017 |  |